



RANCH HOUSE DOORS

— *Redefining the Entrance™* —



CAPE COD COLLECTION



Model: Sconset **Species:** Tricoya **Window:** RHD-SQ-2 **Wood Texture:** Smooth **RHD#245**



Model: Ballston **Species:** Cedar **Window:** RHD-SQ-17 **Wood Texture:** Smooth **RHD#9270**



Model: Chatham **Species:** Tricoya **Window:** RHD-SQ-2 **Wood Texture:** Smooth **RHD#795B**

CAPE COD COLLECTION

The Cape Cod Collection draws from classic Colonial New England architecture. Known for its clean lines and timeless charm, this quintessential American cottage style has become a favorite across the country, complementing homes coast to coast.

IT'S AS EASY AS...



CHOOSE YOUR DOOR STYLE

Timeless Cape Cod designs with paneled and cottage-style options for a coastal charm.

CHOOSE YOUR WOOD TYPE

Premium woods like cedar and mahogany, offering warmth and coastal durability.

CHOOSE YOUR OPTIONS

Add coastal touches like grilles, nautical hardware, or soft whitewashed finishes.

CHOOSE YOUR DOOR STYLE

Scan For More Options



Model: East Chop **Species:** Cedar **Window:** RHD-SQ-2 **Wood Texture:** Smooth **RHD#9271**

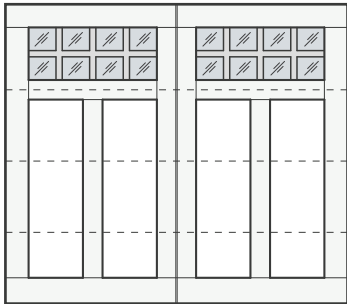

Blackfish

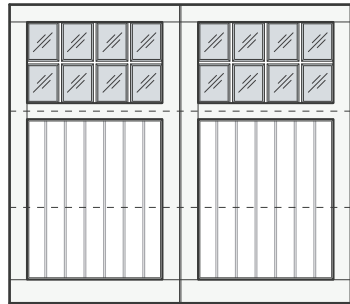

Sconset

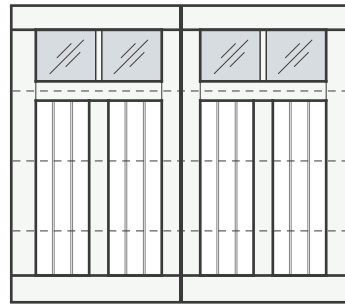

Ballston

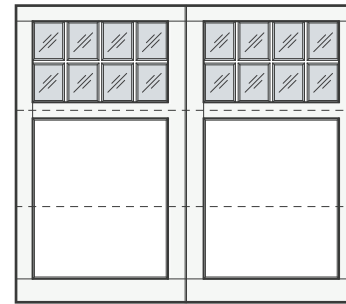

Chatham

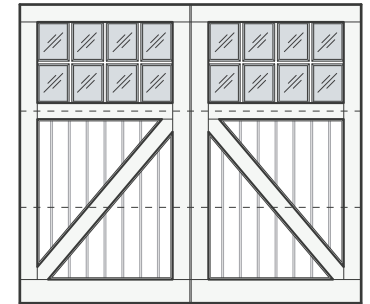

East Chop

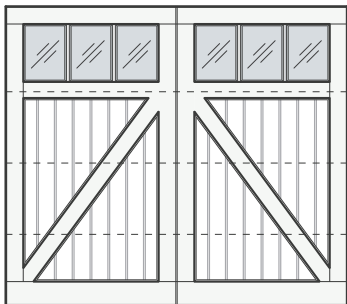

Madaket

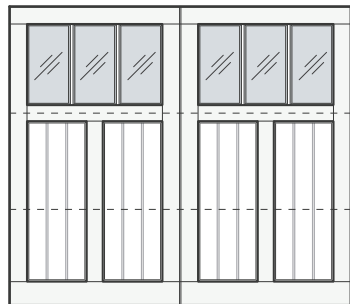

Osterville

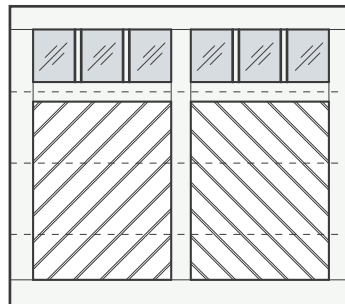

Sunken

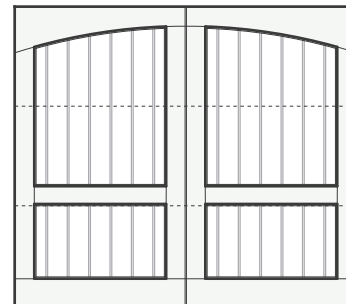

Nantucket

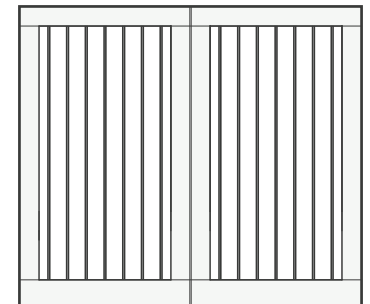

Kingsbury



Model: Ryder Species: Cedar Window: RHD-SQ-4 RHD#8541

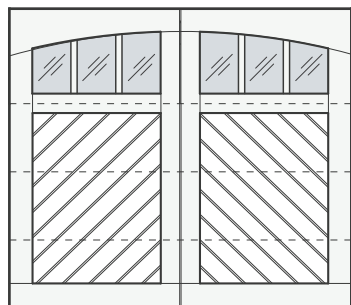

Ryder

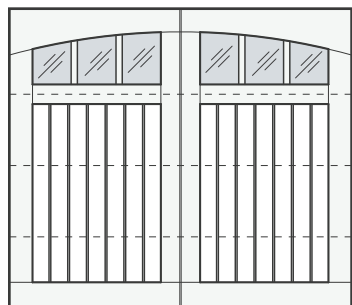

Surfcomber

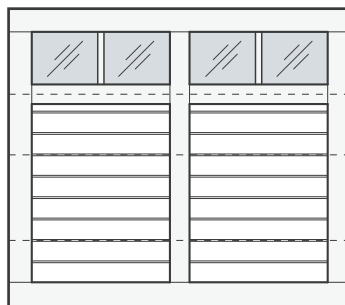

Marconi

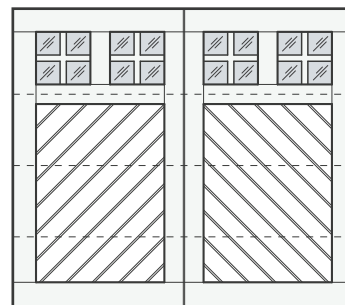

Skaket

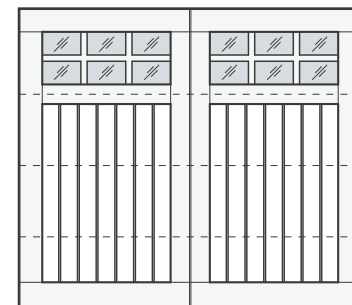

Provincetown

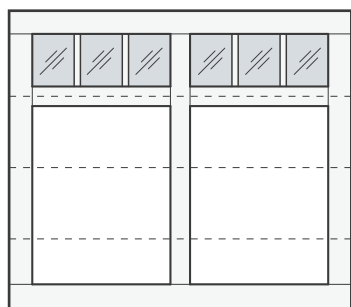

Lighthouse

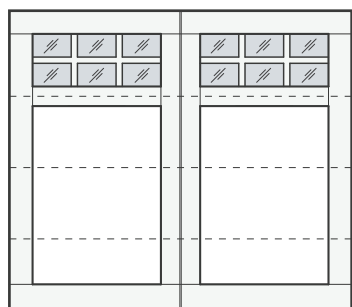

Race Point

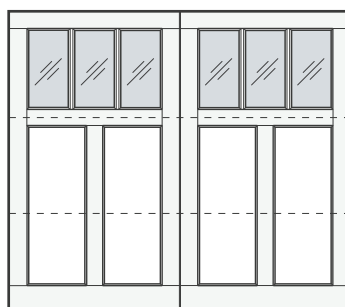

Maybeck

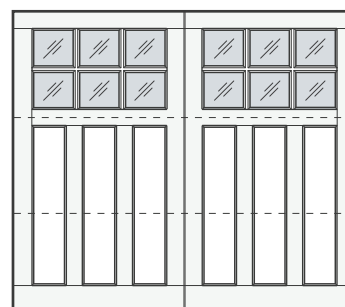

Stickley

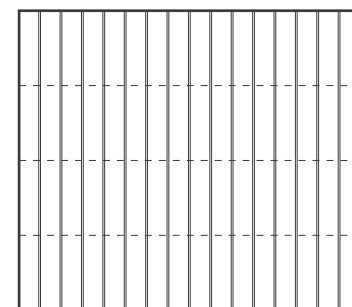

Rapha

6" Nominal

CHOOSE YOUR WOOD TYPE



STAIN GRADE WOODS

Top Recommended



Cedar - *Most Used*
Vertical Grain Western Red Cedar

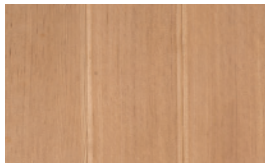

VGDF
Vertical Grain Doug Fir



Hemlock
Vertical Grain Hemlock

PAINT GRADE WOODS

High-quality engineered wood.



Extira Overlay, MDO Plywood Face
Exterior Grade MDF

Additional Species of Woods Available



Meranti Mahogany



African Mahogany



STK Cedar
Select Tight Knot Cedar



White Oak
Vertical Grain or Plain Sawn

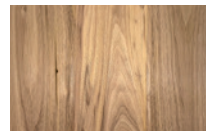

Black Walnut

REclaimed Woods Available



Big Sky Gray
Mixed Pine/Smooth As Is Texture



Nature Aged Fir
Pine and Fir/Circle Sawn Texture



Kentucky Bourbon
Naturally Aged/Circle Sawn Texture



White Birch
Mixed Pine



Marine Meranti
Pine and Fir

REclaimed Cont.

Stain Grade Plywood



LOOKING TO PAINT YOUR DOORS BLACK?

Upgraded Materials - Paint Grade

The guaranteed choice for resistance to ultraviolet rays and water. Tricoya offers a 50-year warranty on the material only and can be painted black. Ranch House has a limited warranty period. Scan the QR code for Tricoya warranty information.

WARRANTY	STANDARD EXTIRA/MDO	tricoya®
	RHD WARRANTY 1 YEAR	RHD WARRANTY 5 YEAR
BLACK/DARK COLORS	EXTRA WARRANTY 9 YEAR	TRICOYA WARRANTY 45 YEAR
HIGH MOISTURE ENVIRONMENT	NOT RECOMMENDED	YES
FULL WEST EXPOSURE	\$	\$\$\$

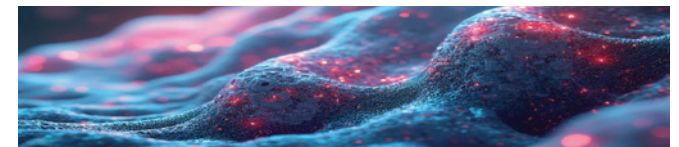

TECHNOLOGICAL TREATED ADVANCED MATERIALS

Stain Grade Options:

- **Thermalized Wood** (e.g., Thermory) – Hemlock, Ash
- **Accoya Wood** – A specialized process alters the wood's cell structure, improving its technical properties to make it significantly stronger and more durable.

• **NewTechWood**

Scan the QR code for more information.



CHOOSE YOUR OPTIONS

3

A WOOD TEXTURES

No Charge



Smooth reSAWN

Additional Charge



Wire Brush
From Left to Right - Light, Medium, Heavy

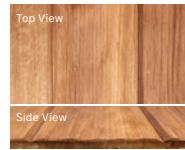

Hand Hewn Distressed

B INTERIOR EDGE OPTIONS



Square



Eased



Coped



Step

C TONGUE & GROOVE OPTIONS



Tongue & Groove, V Joint w/ 3/8" w



Tongue & Groove, Butt Joint



Tongue & Groove, Butt Joint
w/ 1/8" w x 1/8" d Channel Groove



Tongue & Groove, Butt Joint
w/ 1/4" w x 1/8" d Channel Groove

NOTE: Also available in 1 x 2, 1 x 4 and 1 x 8 upon request. Scan QR code for more options.



CUSTOM DOOR SPECIFICATIONS

- **Face and Overlay Materials:** Vary depending on design.
- **Insulation:** 1 3/32" polystyrene insulation.
- **Frame:** 1 3/32" hem fir frame, finger-jointed (FJ).
- **Back:** 1/4" luan plywood.

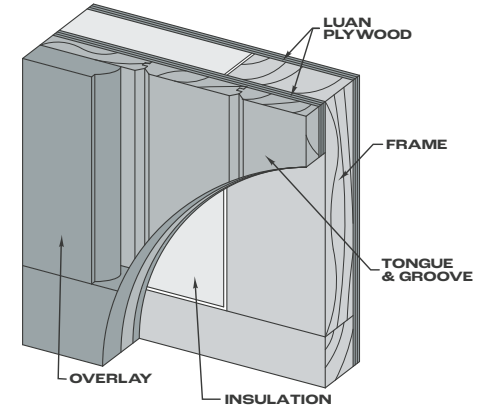
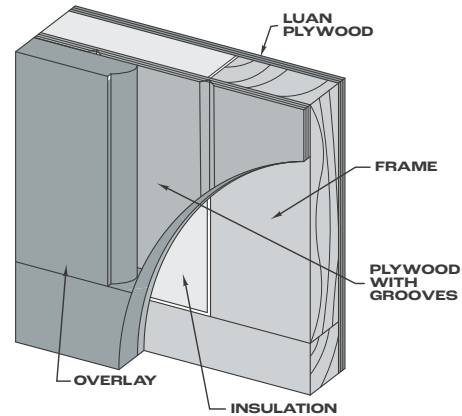

PAINT GRADE

Composites and Plywoods

Used for Tongue-and-Groove face applications:

- **MDO:** 1/2" Medium Density Overlay – a resin-based birch veneer core plywood with phenolic glue for exterior use.
- **Extira:** A resin-based wood composite designed for exterior use.
- **Tricoya:** A resin-based wood composite

Note: We can custom-make plywood from any material you request.

STAIN GRADE

Materials

Used for Tongue-and-Groove face applications:

- **Clear Western Red Cedar**
- **West Coast Hemlock**
- **VG Douglas Fir**
- **Select Tight Knot Western Red Cedar**

Optional Plywood Faces

- **Marine Meranti Plywood**
- **White Birch Plywood**

Other species available upon request.

Scan QR code for more options. Stain grade options available.



HARDWARE UPGRADES



Powder Coated Hardware

- **Black or White Powder Coat Available**
- **Custom Colors Available**

Noise Reduction Package

- **Quiet Hinges**

(Cannot be powder coated)



NEED FIRE-RATED OR WIND LOADED GARAGE DOOR?



WUI Wildland Urban Interface

Built with SFM Standard 12-7A-1 (Wildland Urban Interface Code). Full custom doors only.



Required Wind Loading?

*Compliant with wind load requirements of the 8th Edition (2023) of the Florida Building Code. *In accordance with ANSI/DASMA 108-17.

WINDOW OPTIONS

Note: These tops are drawn for 8-0 x 7-0 doors.

The mullions are 1 3/4" and tru divide lites, unless noted otherwise.

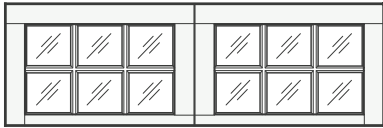

RHD-SQ-1

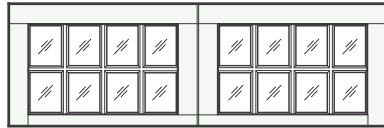

RHD-SQ-2

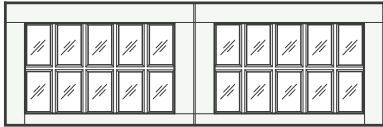

RHD-SQ-3

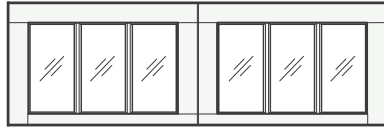

RHD-SQ-4

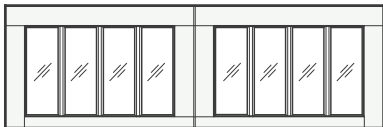

RHD-SQ-5

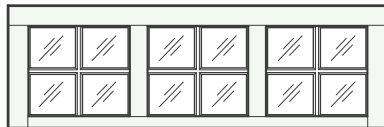

RHD-SQ-6

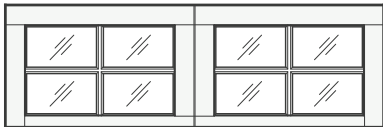

RHD-SQ-7

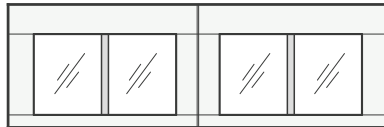

RHD-SQ-17

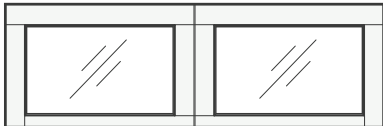

RHD-SQ-15

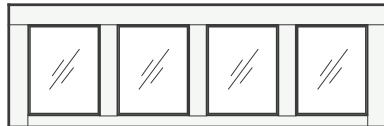

RHD-SQ-16

Aluminum Black Powder Coated Frames

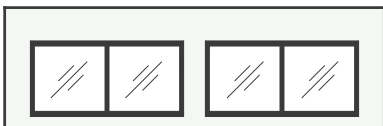

RHD-SQ-17 AL

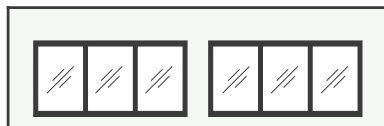

RHD-SQ-4 AL

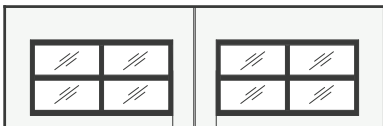

RHD-SQ-7 AL



RHD-SQ-18 AL

*Windows are Tru Divided unless otherwise noted. *Wood windows are Tru Divided.

*Specialty glass available upon request. Arch (AR) can be added to any Square (SQ) design.

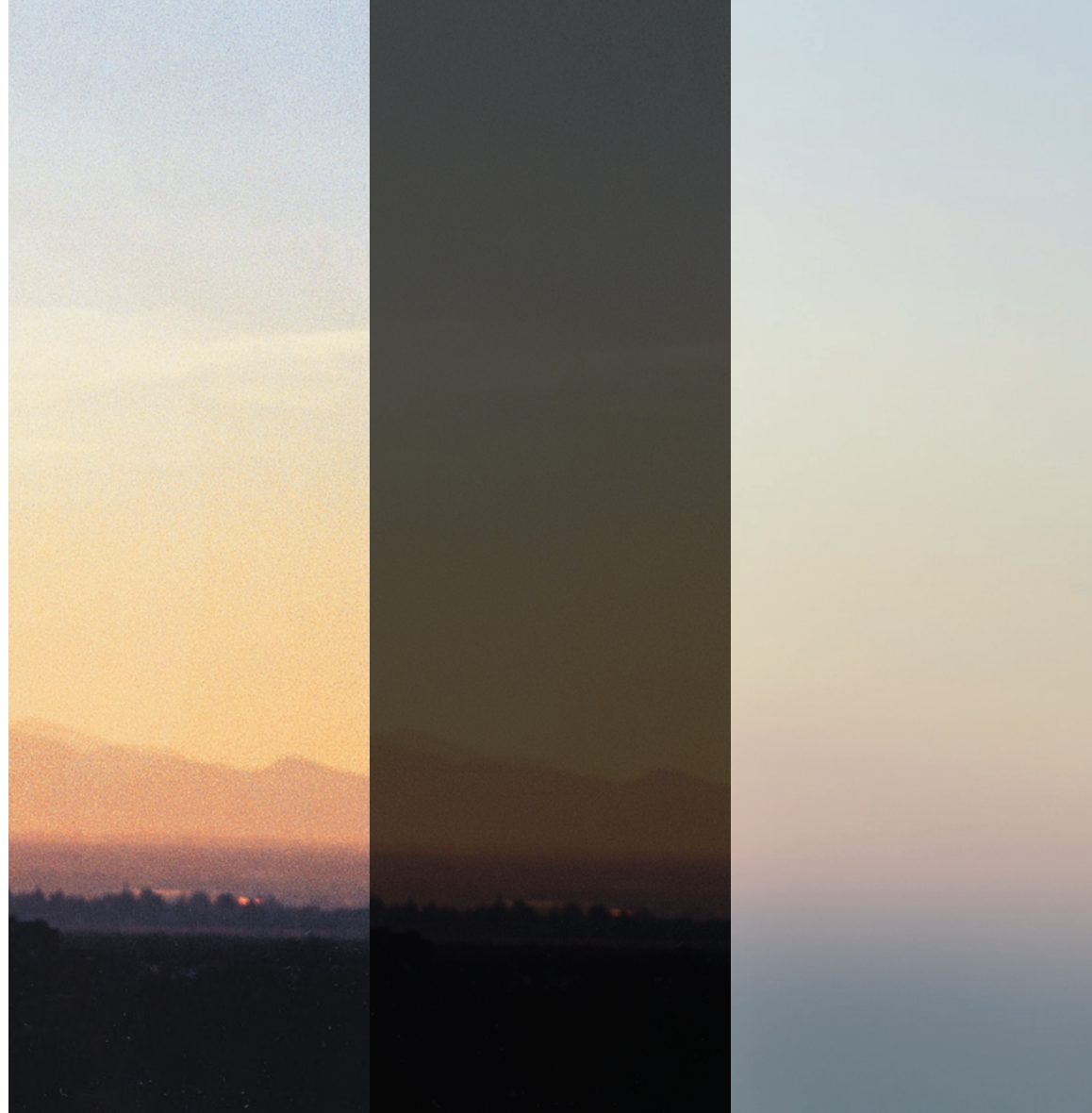

CLEAR
Standard

DARK GRAY
/ TINTED

ACID ETCH
/ FROSTED
w/Durashield

GLASS TYPES



Scan QR code for more options. Clear / Upgrades are available with various types of glass. All glass is Annealed, Tempering is an optional upgrade. Insulated glass available upon request. Copyright Notice: All materials shown in this brochure are copyrighted and may not be duplicated in any form. ©2026 Ranch House Doors.

BUILT ON LEGACY



RANCH HOUSE DOORS

— *Redefining the Entrance™* —



PHONE

951.278.2884

ADDRESS

1527 Pomona Rd,
Corona, CA 92878



Scan the QR code for
RHD warranty/stain information.

In a small La Mirada garage more than two decades ago, our father, Mike Neal, built his first custom wood door. The garage was alive with the sounds of roaring machines, and the air was thick with sawdust—a symbol of hard work and creativity.

Dad often said, “I love the smell of sawdust in the morning.” That passion turned what began as a “little experiment” into Ranch House Doors—one of the nation’s premier door manufacturers.

Today, we carry on Dad’s legacy, creating handcrafted garage doors, entry doors, gates, and more for homes across the country. Our skilled design team is here to turn your ideas into reality, blending timeless craftsmanship with your unique style.

For us, every door is more than just a product; it’s an opportunity to make your home warm, functional, and truly exceptional. Because like Dad always said, “If you can think it, we can build it.”



*Only garage doors featuring the official **Ranch House Doors serial number plate of authenticity** are genuine Ranch House Doors products. This serial number plate represents our commitment to craftsmanship, premium materials, and enduring quality.*

Doors without it are not made or authorized by Ranch House Doors and do not carry our warranty or brand guarantee.

Look for the serial number plate—it’s the mark of true craftsmanship.