



RANCH HOUSE DOORS

— *Redefining the Entrance™* —



CONTEMPORARY COLLECTION



Model: FV-SD-14, FV-DD-24 **Species:** Western Red Cedar
Window: White Laminated **Wood Texture:** Smooth **RHD#707**



Model: MV-DD-25 **Species:** Thermo Ash **Window:** Dark Gray **Wood Texture:** Smooth **RHD#8550A**



Model: PRO-DD-311 (Modified Post) **Species:** Mahogany **Window:** White Laminated
Wood Texture: Smooth **RHD#0764**

CONTEMPORARY COLLECTION

The Contemporary Collection embodies modern design principles, featuring clean lines, bold geometry, and minimalist aesthetics.

This versatile style complements a wide range of homes, bringing a fresh, sophisticated look to any setting.

IT'S AS EASY AS...



CHOOSE YOUR DOOR STYLE

Sleek and modern coastal designs with clean lines and minimalist paneling.

CHOOSE YOUR WOOD TYPE

High-quality woods like cedar and mahogany for a refined yet durable finish.

CHOOSE YOUR OPTIONS

Enhance with subtle coastal accents such as slim grilles, brushed metal hardware, or light, natural stains.



FULL VIEW SERIES – WOOD

Scan For More Options

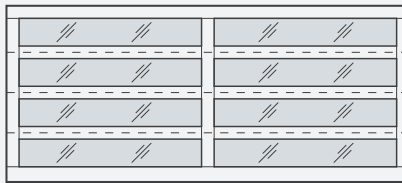

FV-DD-24

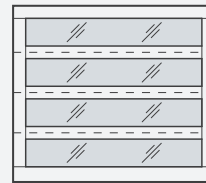

FV-SD-14

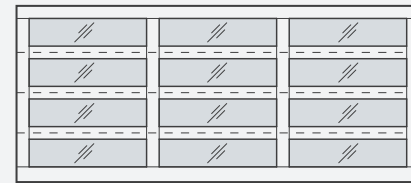

FV-DD-34

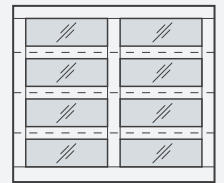

FV-SD-24

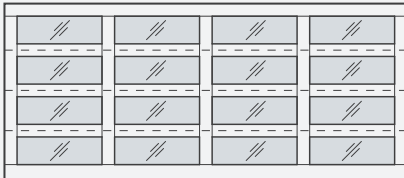

FV-DD-44

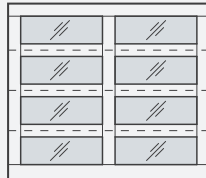

FV-SD-24

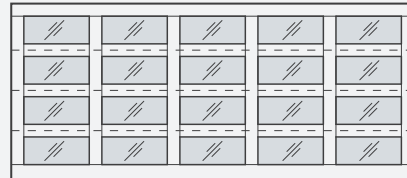

FV-DD-54

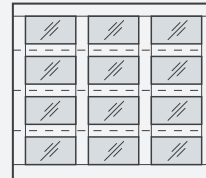

FV-SD-34

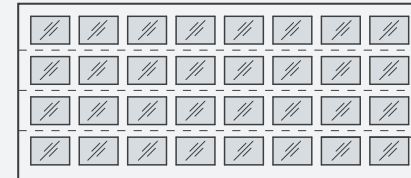

FV-DD-84

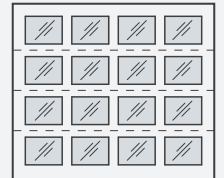

FV-SD-44

MEDIUM VIEW SERIES

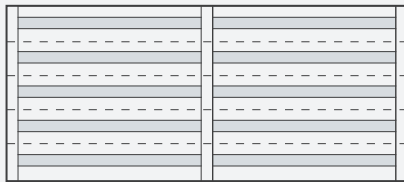

MV-DD-25

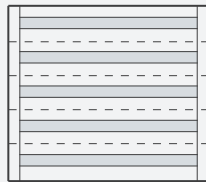

MV-SD-15

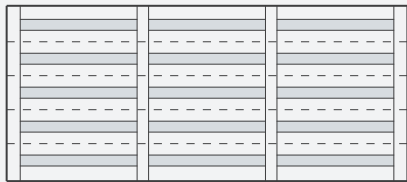

MV-DD-35

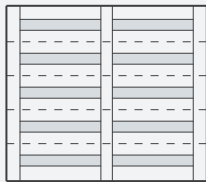

MV-SD-25

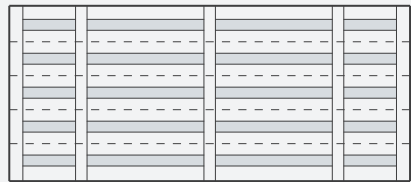

MV-DD-OFFSET-45

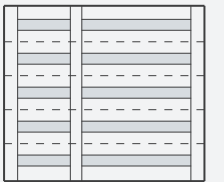

MV-SD-OFFSET-25

PROGRESSIVE SERIES - NARROW/SMALL



PRO-DD-311



PRO-SD-211

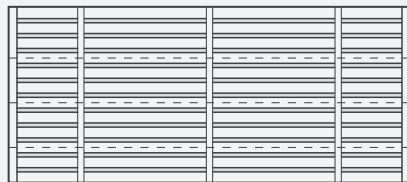

PRO-DD-OFFSET-411

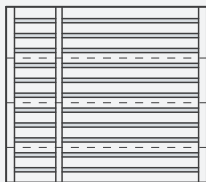

PRO-SD-OFFSET-2L11

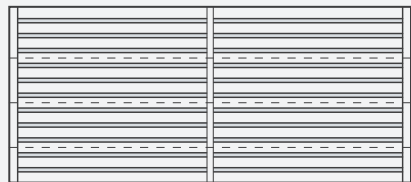

PRO-DD-211

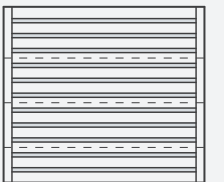

PRO-SD-111

All dimensions are nominal.



Model: MC-DD-34 **Species:** Metal/Aluminum Clad **RHD#9266B**

Model: PLY-DD-44 **Species:** Marine Meranti **Wood Texture:** Smooth **RHD#2126**

METAL/ALUMINUM CLAD OR PLYWOOD SERIES (MCP)

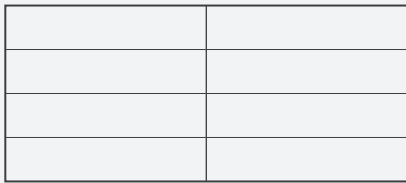

MC-DD-24
PLY-DD-24



MC-SD-14
PLY-SD-14

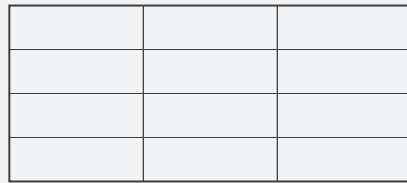

MC-DD-34
PLY-DD-34

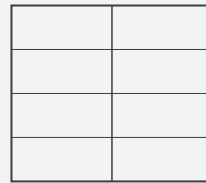

MC-SD-24
PLY-SD-24

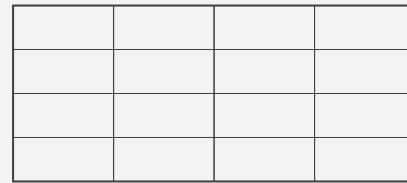

MC-DD-44
PLY-DD-44

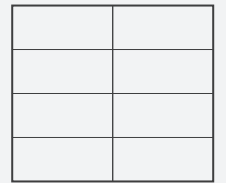

MC-SD-24
PLY-SD-24

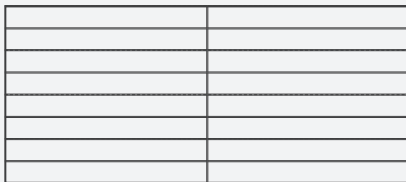

MC-DD-28
PLY-DD-28



MC-SD-18
PLY-SD-18

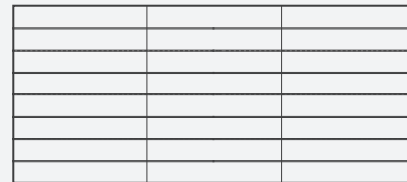

MC-DD-38
PLY-DD-38

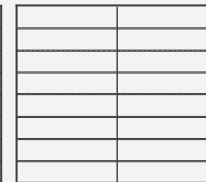

MC-SD-18
PLY-SD-18

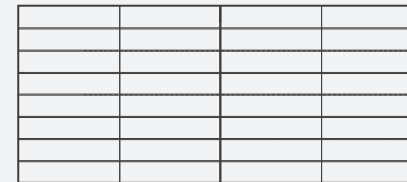

MC-DD-48
PLY-DD-48

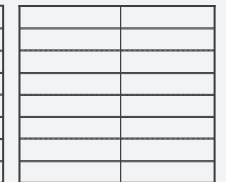

MC-SD-18
PLY-SD-18

MC = Metal Clad. PLY = Plywood. All Designs are Universal.

FLUSH SERIES – TONGUE & GROOVE



FS-DD-HORZ-6"



FS-SD-HORZ-6"



FS-DD-HORZ-8"

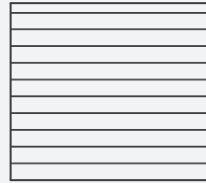

FS-SD-HORZ-8"

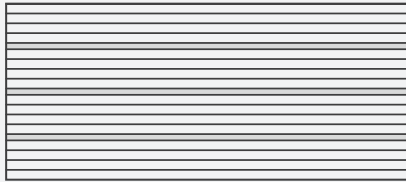

FS-DD-HORZ-6" Option: MCP 3" C-Channel

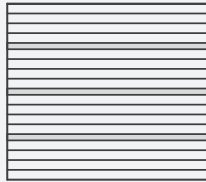

FS-SD-HORZ-6" MCP 3" C-Channel



FS-DD-HORZ-8" Option: MCP 3" C-Channel

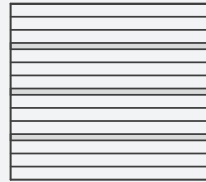

FS-SD-HORZ-8" MCP 3" C-Channel



FS-DD-HORZ-6" Side Window Option: SW-17R

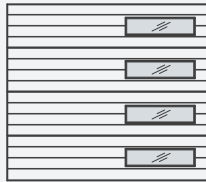

FS-SD-HORZ-6" SW-17R



FS-DD-HORZ-8" Side Window Option: SW-17R

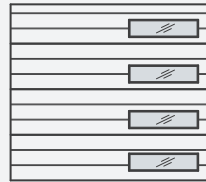

FS-SD-HORZ-8" SW-17R

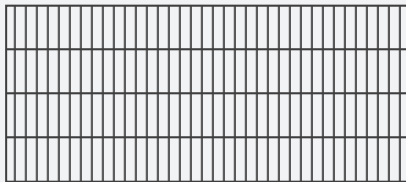

FS-DD-VERT-6"

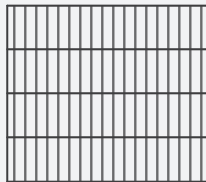

FS-SD-VERT-6"

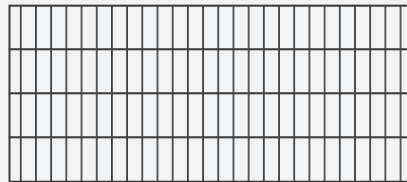

FS-DD-VERT-8"

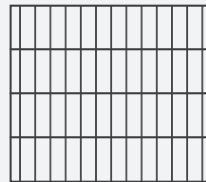

FS-SD-VERT-8"

CHANNEL PROFILE SERIES

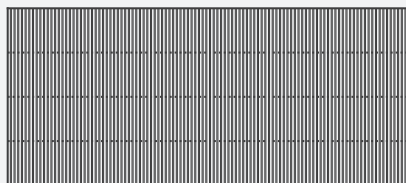

CP-DD-VERT-1.25.5.5

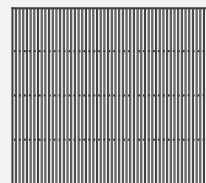

CP-SD-VERT-1.25.5.5



CP-DD-HORZ-1.25.5.5



CP-SD-HORZ-1.25.5.5

* Potential Seam. Contingent on Availability.



Model: FS-DD-HORZ-6" Species: White Oak* Wood Texture: Smooth RHD#9698



Model: FS-DD-HORZ-6" Species: Cedar RHD#9624
Metal Channel Profile (MCP): 3" C-Channel Wood Texture: Smooth



Model: CP-DD-VERT 1.25.5.5 Species: Cedar Wood Texture: Smooth RHD#9273

CHOOSE YOUR WOOD OR METAL TYPE

2



Model: CP-DD-VERT 4" Species: Cedar Wood Texture: Smooth RHD#9274

STANDARD

Woods

LENGTH	CEDAR	VGDF	HEMLOCK	MERANTI	MAHOGANY	WHITE OAK	WALNUT	IPE
	8'	✓	✓	✓	✓	✓	✓	✓
10'	✓	✓	✓	✓	✓	✓	✓	✓
12'	✓	✓	✓	✓	✓	✓		✓
14'	✓	✓	✓	✓	✓	✓		✓
16'	✓	✓	✓	✓	✓	✓*		✓
18'	✓	✓	✓	✓				✓
20'	✓*		✓*	✓*				

* Potential Seam. Contingent on Availability.

PLYWOOD

Pressed

EXTIRA	TRICOYA	MARINE MERANTI
✓	✓	✓
✓	✓	✓
✓		

THERMAL

Woods

THERMO HEMLOCK	THERMO ASH	ACCOYA
✓	✓	✓
✓	✓	✓

Thermal products will lighten over time.

NEW TECH

Composite Woods

NEWTechWOOD
✓
✓

Japanese Cedar Peruvian Teak



LOOKING TO PAINT YOUR DOORS BLACK?

Upgraded Materials - Paint Grade

The guaranteed choice for resistance to ultraviolet rays and water. Tricoya offers a 50-year warranty on the material only and can be painted black. Ranch House has a limited warranty period. Scan the QR code for Tricoya warranty information.

STANDARD
EXTIRA/MDO



WARRANTY	RHD WARRANTY 1 YEAR	RHD WARRANTY 5 YEAR
	EXTRIA WARRANTY 9 YEAR	TRICOYA WARRANTY 45 YEAR
BLACK/DARK COLORS	NOT RECOMMENDED	YES
HIGH MOISTURE ENVIRONMENT	NOT RECOMMENDED	YES
FULL WEST EXPOSURE	\$	\$\$\$

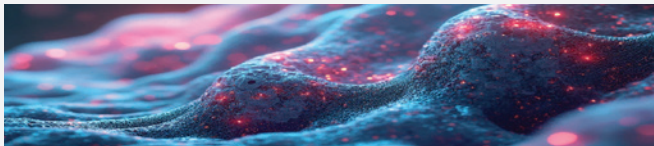

TECHNOLOGICAL TREATED ADVANCED MATERIALS

Stain Grade Options:

- **Thermalized Wood** (e.g., Thermory) – Hemlock, Ash
- **Accoya Wood** – A specialized process alters the wood's cell structure, improving its technical properties to make it significantly stronger and more durable.

- **NewTechWood**

Scan the QR code for more information.



Model: MC-DD-24 Species: Copper RHD#9679

METAL TYPES

Top Recommended

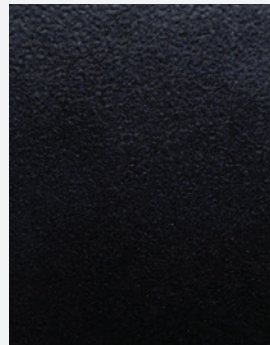

Black - Powder Coat
Custom Color Available, Aluminum PC, Color Custom Powder



Mill Finish - Paint Grade
Painted by Others, Black Paint, No Anodized Black, Disclaimer

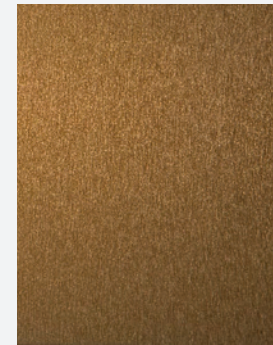

Medium Bronze
Special Materials Upon Request, Disclaimer

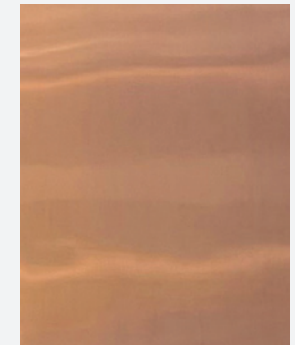

Copper
Vertical Grain

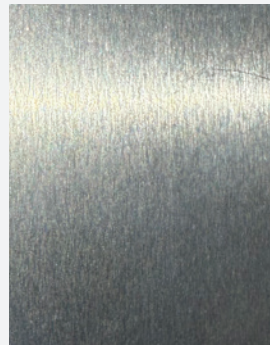

Stainless Steel



Corten Steel
Will Rust or Patina Over Time

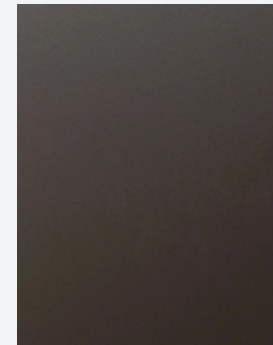

Matte Black Painted .050
Grazing = Stretch Marks

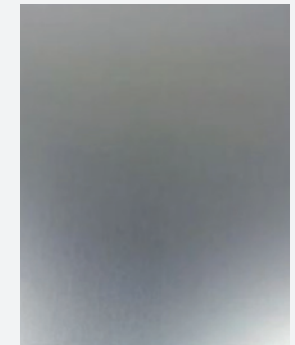

Clear Anodized Aluminum

CHOOSE YOUR
OPTIONS

3

A WOOD TEXTURES



Smooth, No Charge

B INTERIOR EDGE OPTIONS

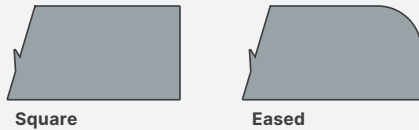

Square

Eased

C TONGUE & GROOVE OPTIONS

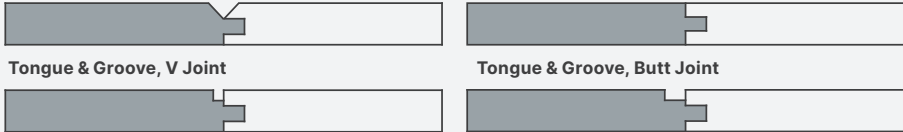

Tongue & Groove, V Joint

Tongue & Groove, Butt Joint

Tongue & Groove, Butt Joint w/ 1/8" w x 1/8" d Channel Groove

Tongue & Groove, Butt Joint w/ 1/4" w x 1/8" d Channel Groove

NOTE: Also available in 1 x 2, 1 x 4 and 1 x 8 upon request. Scan QR code for more options.
1/Thickness materials will have deeper channels. Available in 2", 4", 6", 8", 10"



D METAL CHANNEL PROFILES - OPTIONS

NOTE: Can be added to wood & metal clad.

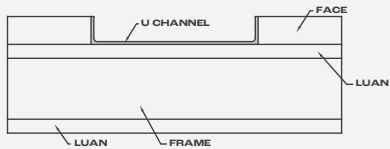

Flush "U" Channel

Double doors = Maximum 16' Aluminum only.
Single doors = Available in 2", 3", 4" all metal options. (Will NOT put center seam)

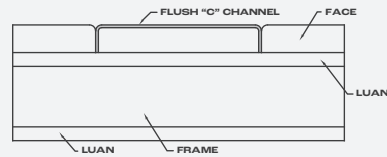

Flush "C" Channel

Single doors = No seam
Double doors = Center seam.
Available in 2", 3", 4". All metal types available.

E CHANNEL PROFILES - WOOD

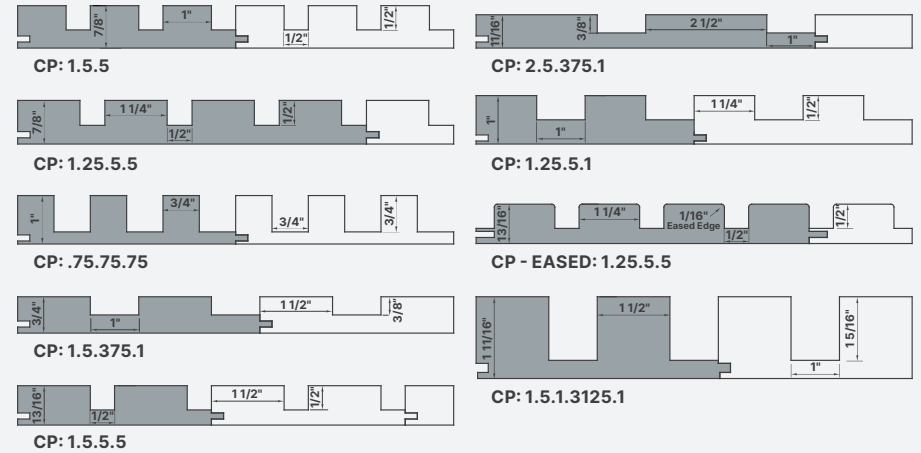

F CHANNEL PROFILES - COMPOSITE WOODS

NOTE: Vertical Only.

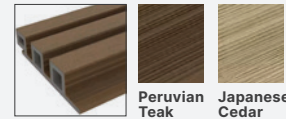

Peruvian Teak

Japanese Cedar

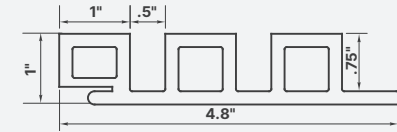

NewTechWood - UH46 - Profile: Norwegian

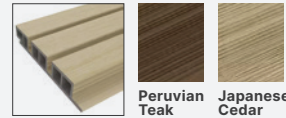

Peruvian Teak

Japanese Cedar

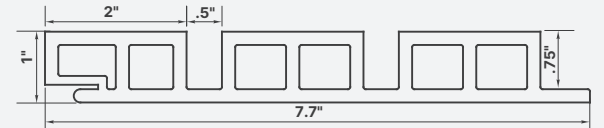

NewTechWood - UH58 - Profile: Belgian

G CHANNEL PROFILES - PLYWOOD

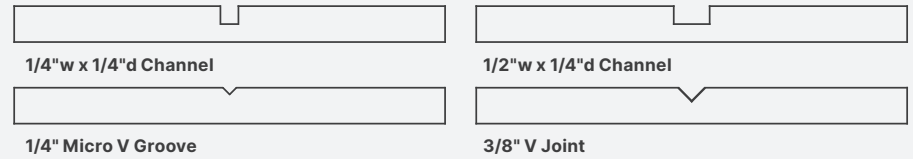

H METAL JOINT OPTIONS Scan QR code for more options.



Knuckle Joint

1/2" Channel





Model: MC-SD-14 **Metal Type:** Black Aluminum **Metal Channel Profile (MCP):** 2" U-Channel RHD#720

Model: FS-SD-VERT-8" **Species:** Walnut **Wood Texture:** Smooth RHD#9638

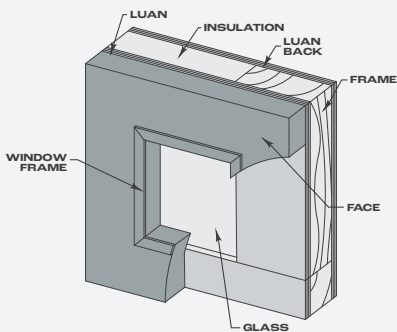

**FULL VIEW/
PROGRESSIVE**

- 4 Layer Construction
- **Thickness:** 2 5/16"
- **Interior Option:** Square
- **White Lami Glass:** Standard
- **Available Options:**
 - See Wood Species
 - See Glass Types

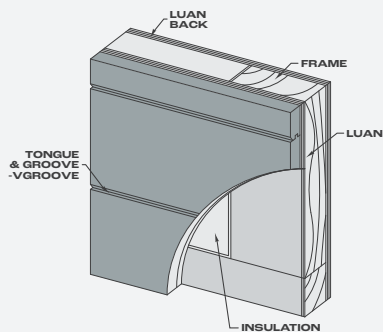

FLUSH T&G

- 4 Layer Construction
- **Thickness:** 2" - 2 1/4"
- **T&G Options:** See Below
- Species Type
- **Available Options:**
 - See Glass Types & Formations
 - See Channel Options
 - See Wood Species

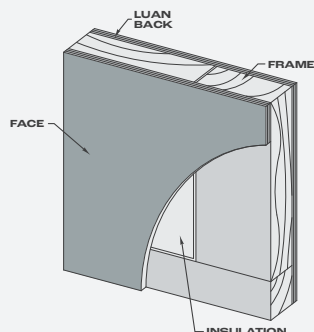

FLUSH PLY

- 3 Layer Construction
- Luan 1/4" Face; Standard
- **Thickness:** 1 5/8"
- **Available Plywoods:**
 - Meranti
 - Mahogany
- **Available Options:**
 - See Glass Types & Formations
 - See Channel Options

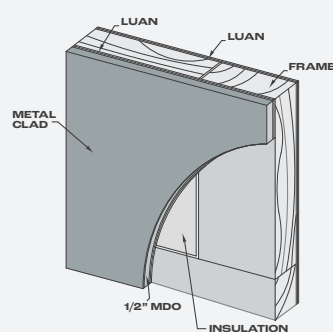

METAL CLAD

- 4 Layer Construction
- **Thickness:** 2"
- **Face:** Selected Metal Type

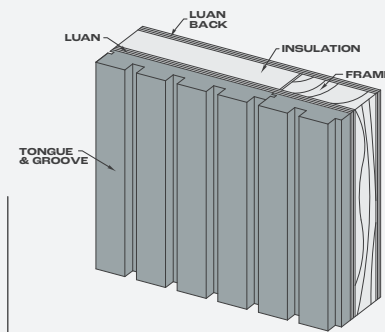

CHANNEL PROFILE

Shown: CP 1.25.5.5

- 4 Layer Construction
- **Thickness:** 2 1/4" - 3"



HARDWARE UPGRADES

Powder Coated Hardware

- Black or White Powder Coat Available
- Custom Colors Available

Noise Reduction Package

- Quiet Hinges

(Cannot be powder coated)



NEED FIRE-RATED OR WIND LOADED GARAGE DOOR?



WUI Wildland Urban Interface

Built with SFM Standard 12-7A-1 (Wildland Urban Interface Code). Full custom doors only.



Required Wind Loading?

*Compliant with wind load requirements of the 8th Edition (2023) of the Florida Building Code.
*In accordance with ANSI/DASMA 108-17.



Model: FV-DD-24 **Species:** Tricoya **Window:** Reeded Glass **Wood Texture:** Smooth **RHD#**9685

SIDE WINDOW OPTIONS

Note: These tops are drawn for 16' x 7' & 8' x 7' doors. The mullions are 1 3/4" and tru divide lites, unless noted otherwise.

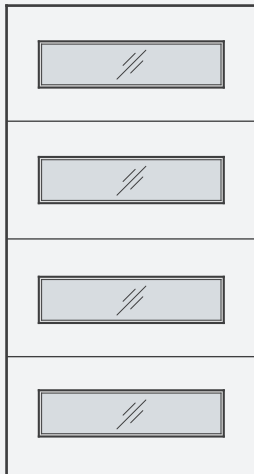

SW-17 (L/R)
Flush Side Windows
4 Sections

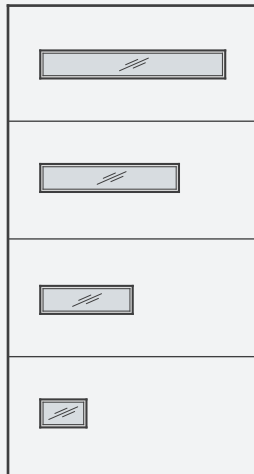

SW-18 (L/R)
Flush Side Thin Taper
Windows 4 Sections



SW-19 (L/R)
Flush Side Windows
4 Section



SW-20 (L/R)
Flush Side Taper
Windows 4 Section



SW-21 (L/R)
Flush Side Thin
Windows 4 Section

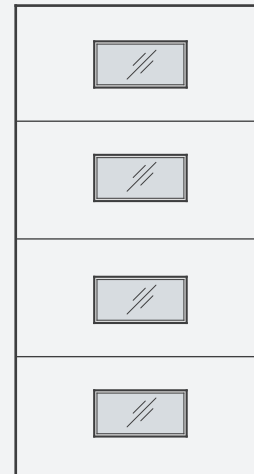

SW-22 (L/R)
Flush Side Short
Windows 4 Sections



SW-23 (L/R)
Flush Side Short Thin
Windows 4 Section

Window section can be reduced. Example; 3 section side window

FLUSH WINDOW TOP OPTIONS

For Double Door



Double-2-Panel



Triple-3-Panel



Quad-4-Panel



Single-10' x 10' - Top *Single Doors Only. Glass Maximum Length 10'*

POWDER COATED FRAMES

Aluminum Black



Double-2-Panel



Triple-3-Panel



Quad-4-Panel



Single-10' x 10' - Top *Single Doors Only. Glass Maximum Length 10'*

*Windows are Tru Divided unless otherwise noted. *Wood windows are Tru Divided.

*Specialty glass available upon request. Arch (AR) can be added to any Square (SQ) design.

GLASS TYPES



Scan QR code for more options. Clear / Upgrades are available with various types of glass. All glass is Annealed, Tempering is an optional upgrade. Insulated glass available upon request. Copyright Notice: All materials shown in this brochure are copyrighted and may not be duplicated in any form. ©2026 Ranch House Doors.

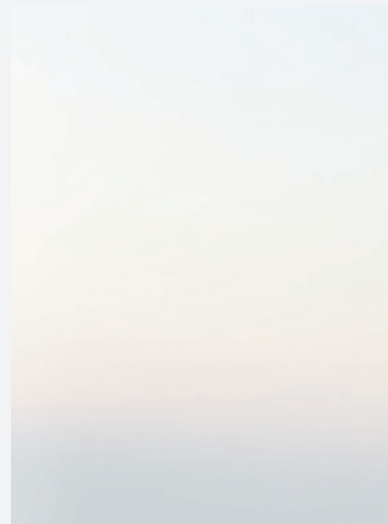

White Laminated

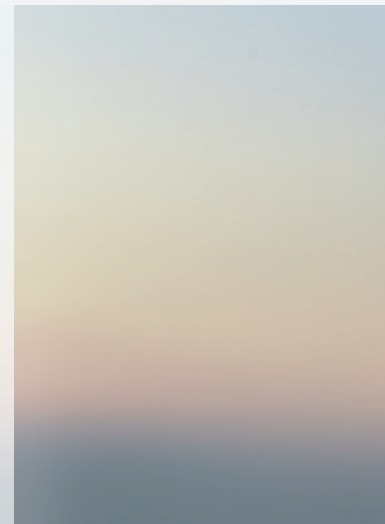

Acid Etch
w/Durashield

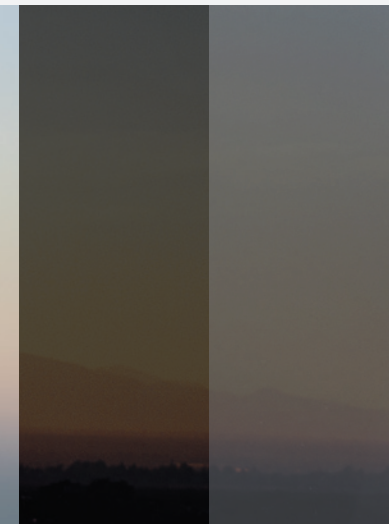

Dark Gray

Dark Gray
w/Sand Blast
Durashield

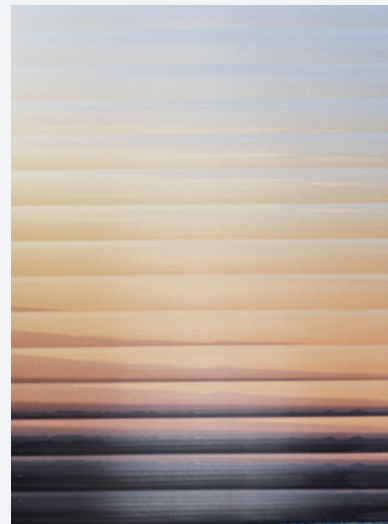

Reeded Glass
1/2" Flutes



Clear Laminated

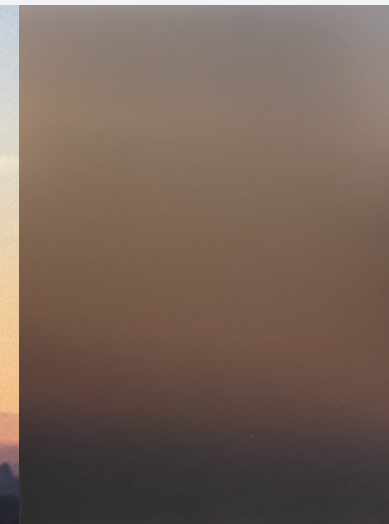

Bronze

BUILT ON LEGACY



RANCH HOUSE DOORS

— *Redefining the Entrance™* —



PHONE

951.278.2884

ADDRESS

1527 Pomona Rd,
Corona, CA 92878



Scan the QR code for
RHD warranty/stain information.

In a small La Mirada garage more than two decades ago, our father, Mike Neal, built his first custom wood door. The garage was alive with the sounds of roaring machines, and the air was thick with sawdust—a symbol of hard work and creativity.

Dad often said, “I love the smell of sawdust in the morning.” That passion turned what began as a “little experiment” into Ranch House Doors—one of the nation’s premier door manufacturers.

Today, we carry on Dad’s legacy, creating handcrafted garage doors, entry doors, gates, and more for homes across the country. Our skilled design team is here to turn your ideas into reality, blending timeless craftsmanship with your unique style.

For us, every door is more than just a product; it’s an opportunity to make your home warm, functional, and truly exceptional. Because like Dad always said, “If you can think it, we can build it.”



*Only garage doors featuring the official **Ranch House Doors serial number plate of authenticity** are genuine Ranch House Doors products. This serial number plate represents our commitment to craftsmanship, premium materials, and enduring quality.*

Doors without it are not made or authorized by Ranch House Doors and do not carry our warranty or brand guarantee.

Look for the serial number plate—it’s the mark of true craftsmanship.