



RANCH HOUSE DOORS

— *Redefining the Entrance* —



**FARMHOUSE COLLECTION**



**Model:** Rio **Species:** Cedar **Window:** RHD-SQ-17 AL **Wood Texture:** Wire Brush **RHD#9245**



**Model:** Marie **Species:** Paint Grade Extira MDO **Window:** RHD-SQ-17 **Wood Texture:** Smooth **RHD#814**



**Model:** Progressive **Species:** Nature Aged Fir **Window:** White Laminated **Wood Texture:** Texture as is **RHD#8047**

# FARMHOUSE COLLECTION

Capture the timeless appeal of the modern farmhouse aesthetic with these handcrafted, all-wood garage doors. Featuring clean lines, they combine rustic charm with contemporary sophistication.

## IT'S AS EASY AS...



### CHOOSE YOUR DOOR STYLE

Clean lines and rustic charm come together in modern farmhouse designs.

### CHOOSE YOUR WOOD TYPE

Choose durable woods like cedar for a warm, natural farmhouse feel.

### CHOOSE YOUR OPTIONS

Customize with black hardware or minimalist window accents.

# CHOOSE YOUR DOOR STYLE



Scan For More Options



Model: Willow Species: Vintage Window: NA Wood Texture: Vintage as is RHD#9687

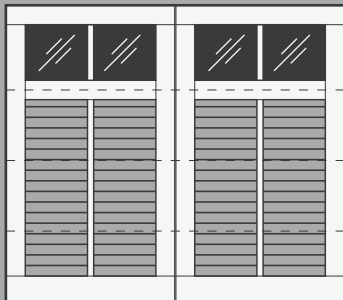

Rio



Marie

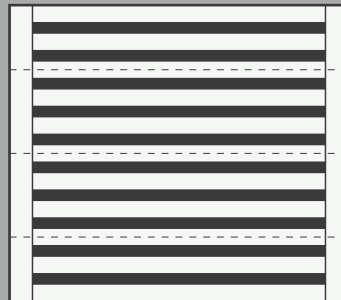

Progressive

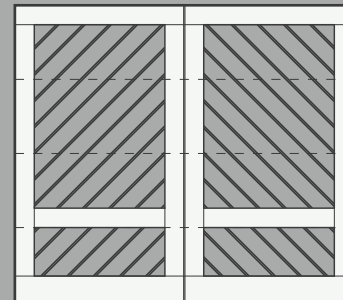

Willow

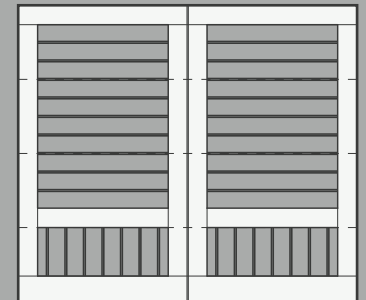

Samantha

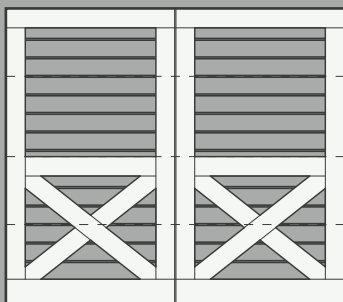

Westley

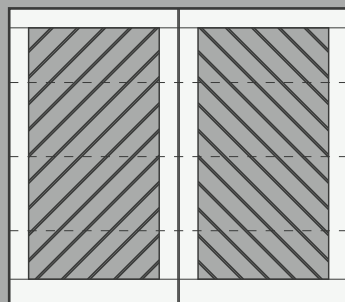

Gracie

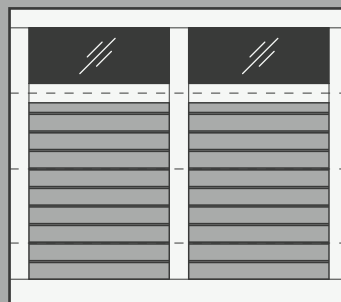

Presley

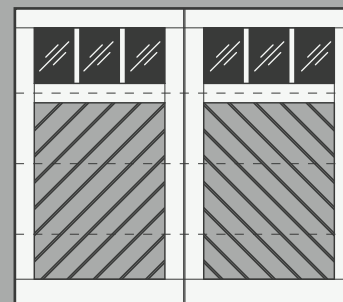

Colby

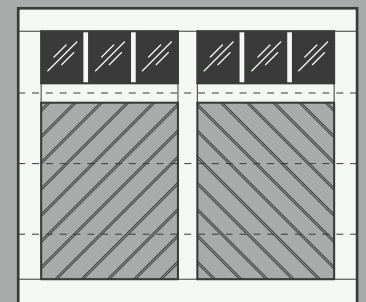

Finley



Model: Franky Species: Extira Window: RHD-SQ-1 RHD#8036

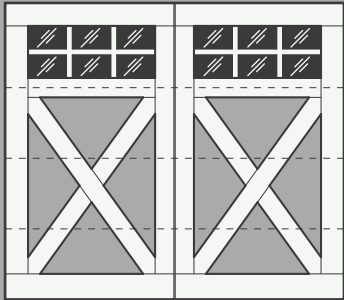

Franky

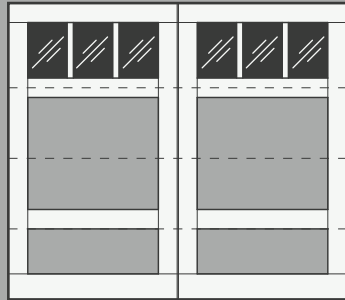

Olive

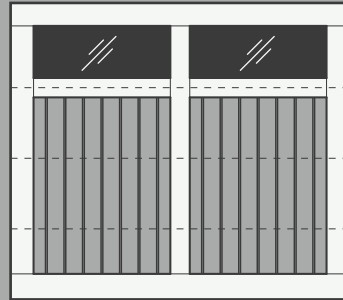

Francis

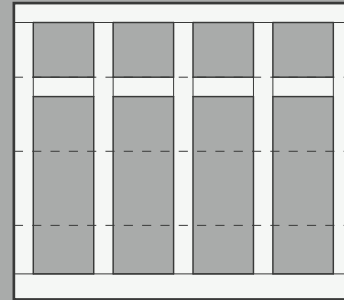

Gains

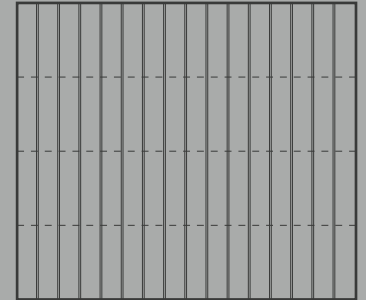

Rapha

6" Nominal

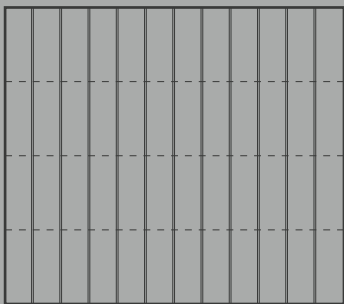

Fenway

8" Nominal



Shelby

6" Nominal



Zuki

8" Nominal

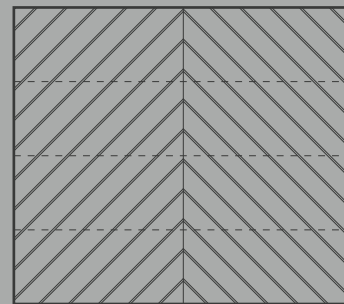

Nealtan

6" Nominal

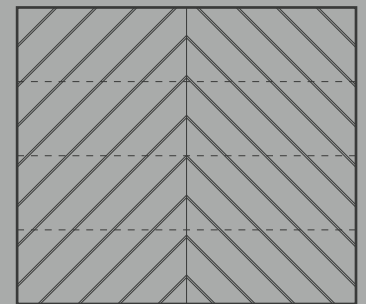

Gonzo

8" Nominal

# CHOOSE YOUR WOOD TYPE

# 2

## STAIN GRADE WOODS

*Top Recommended*



**Cedar - \*Most Used\***  
Vertical Grain Western Red Cedar



**VGDF**  
Vertical Grain Doug Fir



**Hemlock**  
Vertical Grain Hemlock

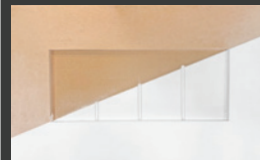

**Extira Overlay, MDO Plywood Face**  
Exterior Grade MDF

*Additional Species of Woods Available*



**Meranti Mahogany**



**African Mahogany**



**STK Cedar**  
Select Tight Knot Cedar



**White Oak**  
Vertical Grain or Plain Sawn

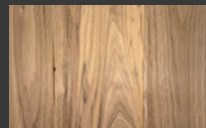

**Black Walnut**

*Reclaimed Woods Available*

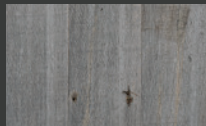

**Big Sky Gray**  
Mixed Pine/Smooth As Is Texture

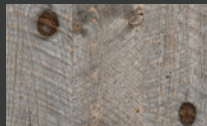

**Nature Aged Fir**  
Pine and Fir/Circle Sawn Texture



**Kentucky Bourbon**  
Naturally Aged/Circle Sawn Texture



**White Birch**  
Mixed Pine



**Marine Meranti**  
Pine and Fir

*Reclaimed Cont.*

*Stain Grade Plywood*

## PAINT GRADE WOODS

*High-quality engineered wood.*

tricoya 



## LOOKING TO PAINT YOUR DOORS BLACK?

*Upgraded Materials - Paint Grade*

The guaranteed choice for resistance to ultraviolet rays and water. Tricoya offers a 50-year warranty on the material only and can be painted black. Scan the QR code for Tricoya warranty information.

WARRANTY	STANDARD EXTIRA/MDO	tricoya 
	RHD WARRANTY 1 YEAR	RHD WARRANTY 5 YEAR
BLACK/DARK COLORS	EXTRA WARRANTY 9 YEAR	TRICOYA WARRANTY 45 YEAR
HIGH MOISTURE ENVIRONMENT	NOT RECOMMENDED	YES
FULL WEST EXPOSURE	\$	\$\$\$

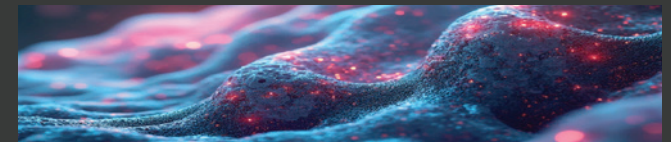

## TECHNOLOGICAL TREATED ADVANCED MATERIALS

*Stain Grade Options:*

- **Thermalized Wood** (e.g., Thermory) – Hemlock, Ash
- **Accoya Wood** – A specialized process alters the wood's cell structure, improving its technical properties to make it significantly stronger and more durable.

• **NewTechWood**

Scan the QR code for more information.



# CHOOSE YOUR OPTIONS

# 3

## A WOOD TEXTURES

No Charge

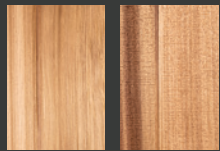

Smooth reSAWN

Additional Charge



Wire Brush  
From Left to Right - Light, Medium, Heavy

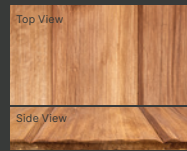

Hand Hewn Distressed

## B INTERIOR EDGE OPTIONS



Square



Eased



Coped



Step

## C TONGUE & GROOVE OPTIONS



Tongue & Groove, V Joint w/ 3/8" w



Tongue & Groove, Butt Joint



Tongue & Groove, Butt Joint  
w/ 1/8" w x 1/8" d Channel Groove



Tongue & Groove, Butt Joint  
w/ 1/4" w x 1/8" d Channel Groove



NOTE: Also available in 1 x 2, 1 x 4 and 1 x 8 upon request. Scan QR code for more options.

## CUSTOM DOOR SPECIFICATIONS

- **Face and Overlay Materials:** Vary depending on design.
- **Insulation:** 1 3/32" polystyrene insulation.
- **Frame:** 1 3/32" hem fir frame, finger-jointed (FJ).
- **Back:** 1/4" luan plywood.

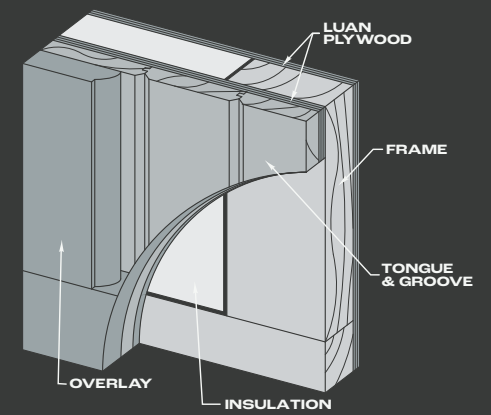
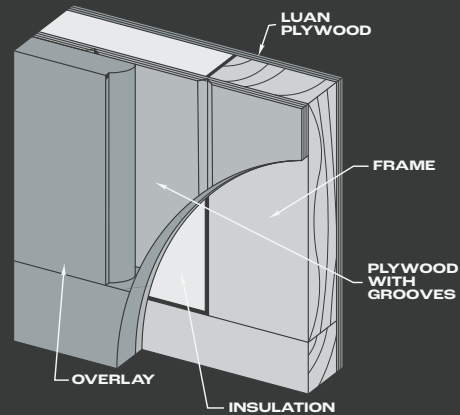

## PAINT GRADE

### Composites and Plywoods

Used for Tongue-and-Groove face applications:

- **MDO:** 1/2" Medium Density Overlay – a resin-based birch veneer core plywood with phenolic glue for exterior use.
- **Extira:** A resin-based wood composite designed for exterior use.
- **Tricoya:** A resin-based wood composite

Note: We can custom-make plywood from any material you request.

## STAIN GRADE

### Materials

Used for Tongue-and-Groove face applications:

- **Clear Western Red Cedar**
- **West Coast Hemlock**
- **VG Douglas Fir**
- **Select Tight Knot Western Red Cedar**

Optional Plywood Faces

- **Marine Meranti Plywood**
- **White Birch Plywood**

Other species available upon request.

Scan QR code for more options. Stain grade options available.



## HARDWARE UPGRADES

### Powder Coated Hardware

- **Black or White Powder Coat Available**
- **Custom Colors Available**

### Noise Reduction Package

- **Quiet Hinges**

(Cannot be powder coated)



## NEED FIRE-RATED OR WIND LOADED GARAGE DOOR?



### WUI Wildland Urban Interface

Built with SFM Standard 12-7A-1 (Wildland Urban Interface Code). Full custom doors only.



### Required Wind Loading?

\*Compliant with wind load requirements of the 8th Edition (2023) of the Florida Building Code. \*In accordance with ANSI/DASMA 108-17.

# WINDOW OPTIONS

**Note:** These tops are drawn for 8-0 x 7-0 doors.

The mullions are 1 3/4" and tru divide lites, unless noted otherwise.

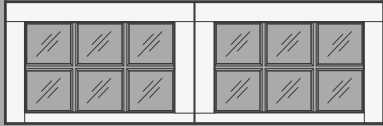

RHD-SQ-1

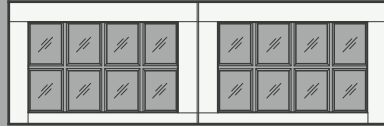

RHD-SQ-2

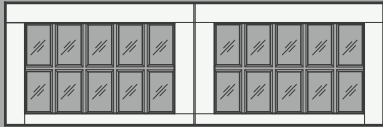

RHD-SQ-3

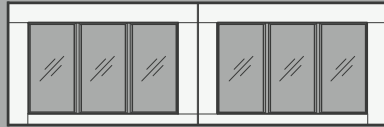

RHD-SQ-4

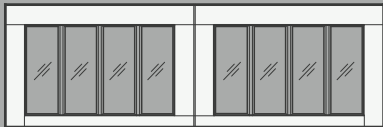

RHD-SQ-5



RHD-SQ-6

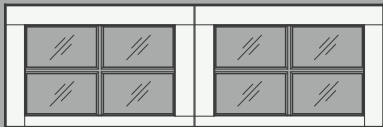

RHD-SQ-7

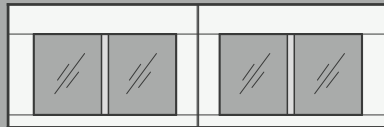

RHD-SQ-17

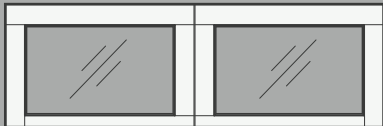

RHD-SQ-15

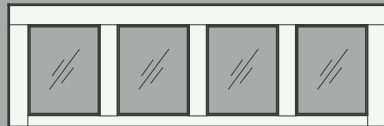

RHD-SQ-16

## Aluminum Black Powder Coated Frames



RHD-SQ-17 AL



RHD-SQ-4 AL



RHD-SQ-7 AL



RHD-SQ-18 AL

\*Windows are Tru Divided unless otherwise noted. \*Wood windows are Tru Divided.

\*Specialty glass available upon request. Arch (AR) can be added to any Square (SQ) design.



**CLEAR**  
Standard

**DARK GRAY**  
/ TINTED

**ACID ETCH**  
/ FROSTED  
w/Durashield

## GLASS TYPES



Scan QR code for more options. Clear / Upgrades are available with various types of glass. All glass is Annealed, Tempering is an optional upgrade. Insulated glass available upon request. Copyright Notice: All materials shown in this brochure are copyrighted and may not be duplicated in any form. ©2026 Ranch House Doors.

# BUILT ON LEGACY



## RANCH HOUSE DOORS

— *Redefining the Entrance* —



### PHONE

951.278.2884

### ADDRESS

1527 Pomona Rd,  
Corona, CA 92878



Scan the QR code for  
RHD warranty/stain information.

In a small La Mirada garage more than two decades ago, our father, Mike Neal, built his first custom wood door. The garage was alive with the sounds of roaring machines, and the air was thick with sawdust—a symbol of hard work and creativity.

Dad often said, “I love the smell of sawdust in the morning.” That passion turned what began as a “little experiment” into Ranch House Doors—one of the nation’s premier door manufacturers.

Today, we carry on Dad’s legacy, creating handcrafted garage doors, entry doors, gates, and more for homes across the country. Our skilled design team is here to turn your ideas into reality, blending timeless craftsmanship with your unique style.

For us, every door is more than just a product; it’s an opportunity to make your home warm, functional, and truly exceptional. Because like Dad always said, “If you can think it, we can build it.”



Only garage doors featuring the official **Ranch House Doors serial number plate of authenticity** are genuine Ranch House Doors products. This serial number plate represents our commitment to craftsmanship, premium materials, and enduring quality. Doors without it are not made or authorized by Ranch House Doors and do not carry our warranty or brand guarantee. **Look for the serial number plate—it’s the mark of true craftsmanship.**